



MANUAL
OPERATION



HOTEL
TRACK

FOREST CS[®] *Contract System*

Heavy duty hand drawn curtain track system for medium and heavy draperies.

THE WORLD
BEHIND
YOUR
CURTAINS



FOREST CS®



PRODUCT INFORMATION

- Heavy duty hand drawn system for medium and heavy draperies.
- Bendable; it can be curved and reversed curved using a 20 cm (8") radius or continuous curve.
- Heavy duty clickable carriers - 10 carriers on a breakaway strip - UV protected. Can also be used with ball bearing carriers.
- Ideal for use with overlap masters and batons which can be mounted behind or in front of draperies.
- Can also be used for the Forest Wave System (FES) and accordiafold drapery systems.
- Maximum fabric weight: 15 kg per mtr (11,25 LBS per ft).
- Colours available: white, black and grey.
- Track finish: High quality aluminium, powder coated with a factory applied patented dry lubricant.
- Available lengths: 3.66 m (12'), 4.27 m (14'), 4.88 m (16'), 6.10 m (20')
- Limited lifetime warranty.

- 1 CS Track
- 2 Carrier
- 3 Master Carrier R/L Overlap
- 4 Master Carrier R/L Underlap
- 5 Ball bearing carrier
- 6 Endcap with screw

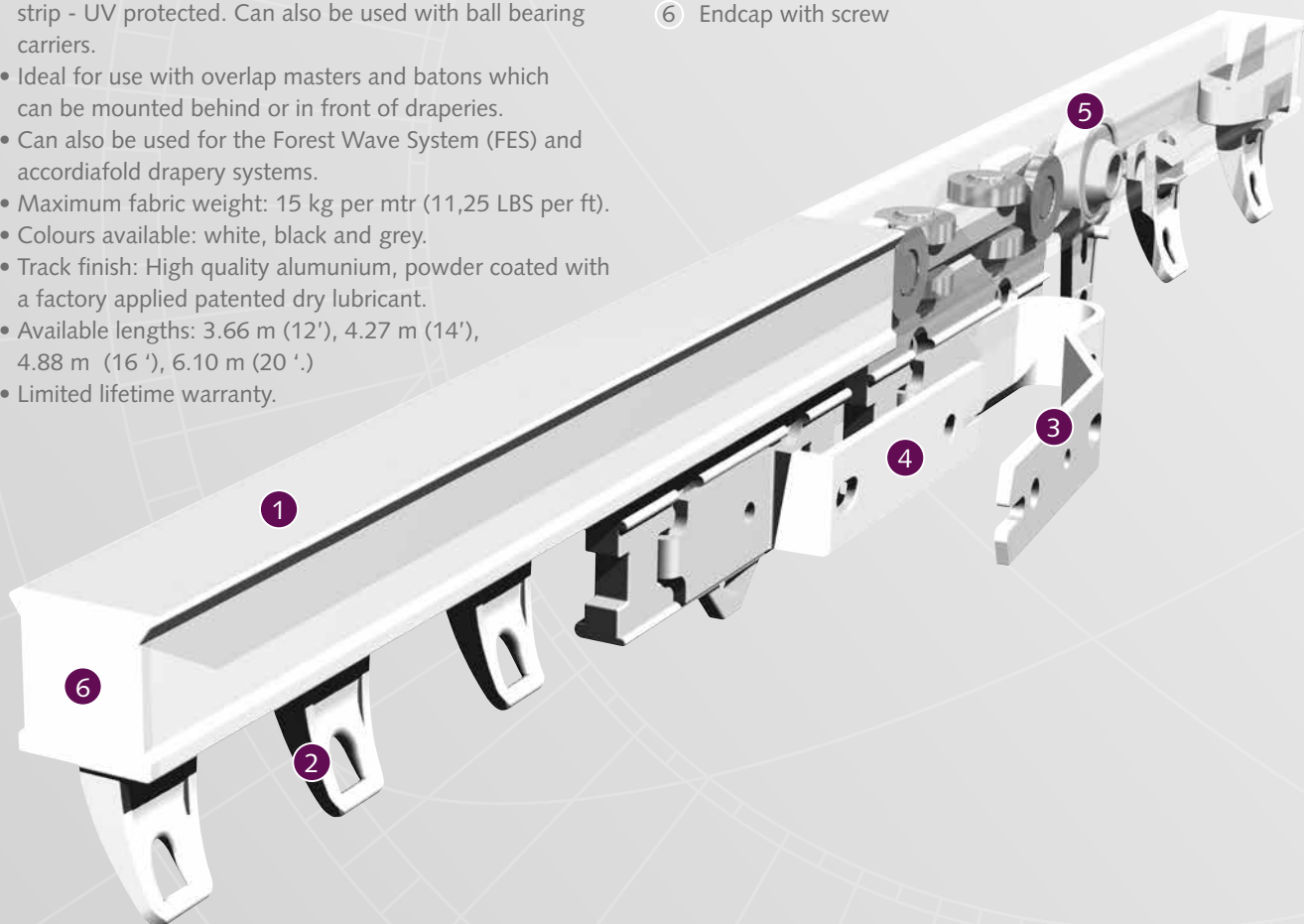



PROFILE

- Weight: 235 gram p. mtr (2.53 ounce - ft).
- Aluminium Extrusion
- Dimensions: 20 mm x 20 mm (0,8" x 0,8")

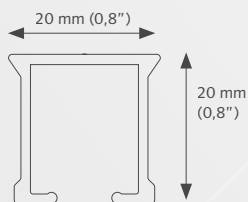

FOR USE IN

Hotels - Motels - offices - schools - healthcare residential or at any location where a heavy duty hand drawn system is required.

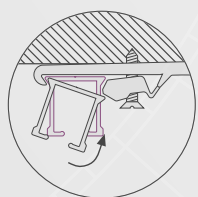

Easy installation
click - position - tighten

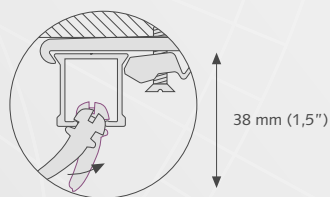

clickable carrier

BENDING / CURVING

The track can be curved and reversed curved using a 20 cm (8") radius. Continuous curving is also possible with the electrical bending tool.

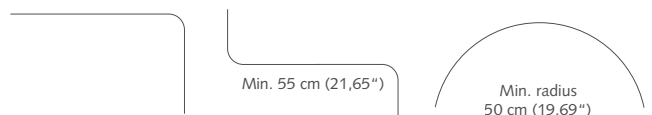

APPLICATIONS

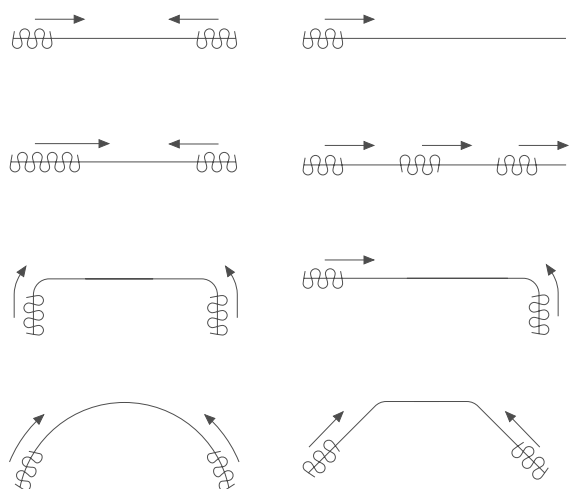

CLICK-ON STIFFENER

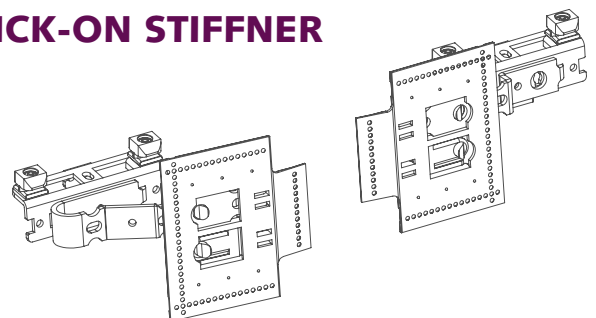

For applications where the curtains are treated very roughly, the stiffener is a sustainable solution. The stiffener makes curtains more robust and ensures that curtains last longer. Especially useful for hotels.

MOUNTING BRACKETS

Smart Klick Ceiling bracket

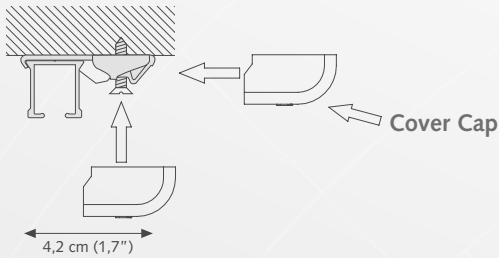

A) Min. 20 cm (8")



A) Min. 20 cm (8")

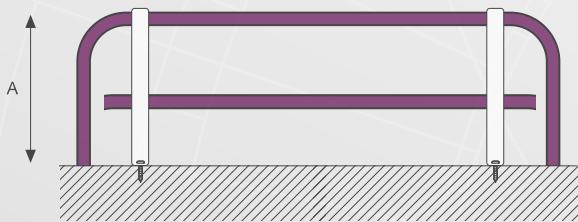

Other brackets are available. Brackets need to be placed every 60 cm (24").

SK Aluminium Wall bracket single

- A) 7,5 cm (3") B) 6,3 cm (2,5")
A) 10 cm (4") B) 8,8 cm (3,5")

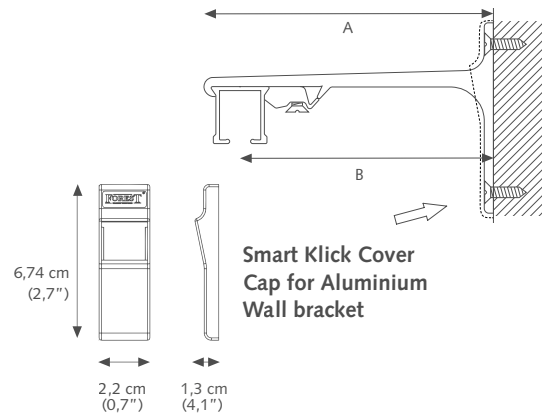

Smart Klick Cover
Cap for Aluminium
Wall bracket

SK Aluminium Wall bracket double

- A) 15 cm (6") B) 9,2 cm (3,6") C) 4,5 cm (1,8")
A) 20 cm (8") B) 9,2 cm (3,6") C) 9,5 cm (3,7")

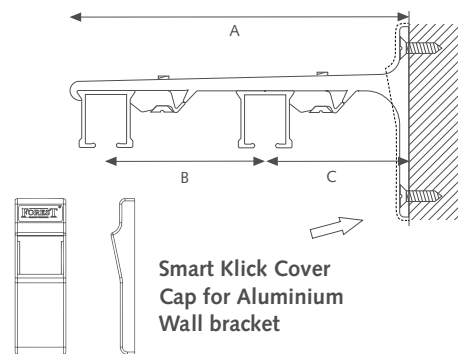

Smart Klick Cover
Cap for Aluminium
Wall bracket



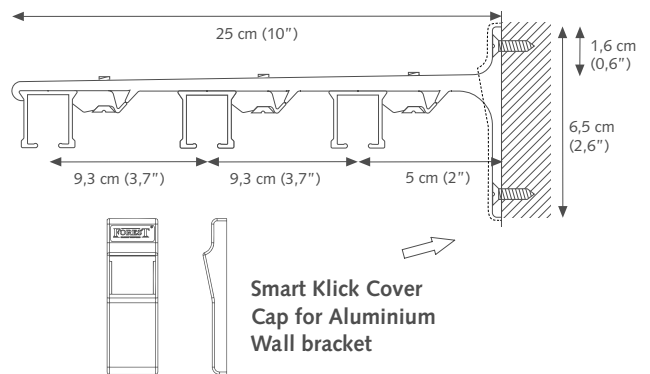

SK Aluminium Wall bracket triple



- A) 25 cm (10")

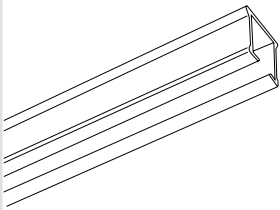
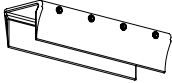
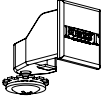
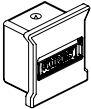
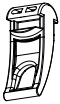



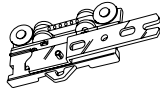
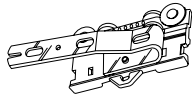

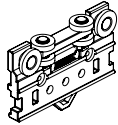
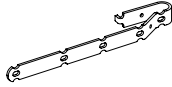
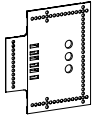
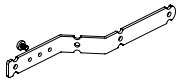
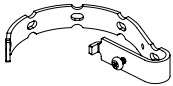

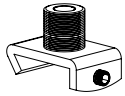
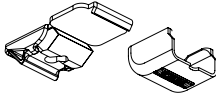
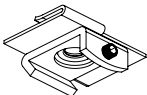
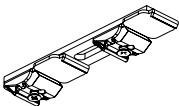
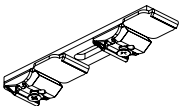
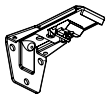
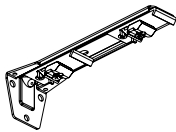
Smart Klick Cover
Cap for Aluminium
Wall bracket

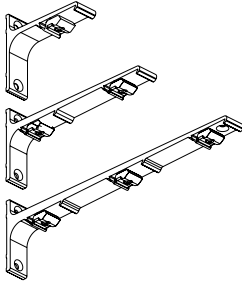
Brackets need to be placed every 50 - 60 cm (20"), depending on fabric weight.

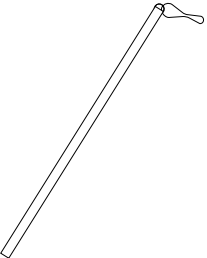
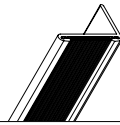
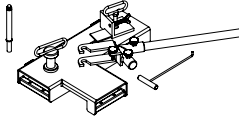
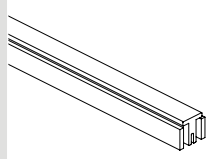
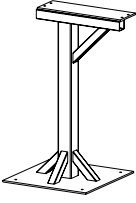
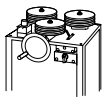
CS	ARTICLE	PACKING UNIT		ART.NR	
●		CS TRACK WHITE Extruded aluminium chromated, powder coating, factory lubricated.	10/bundle	3,66 meter (12') 4,27 meter (14') 4,88 meter (16') 6,10 meter (20')	2501001366 2501001427 2501001488 2501001610
		CS TRACK GREY Extruded aluminium chromated, powder coating, factory lubricated	10/bundle	4,88 meter (16') 6,10 meter (20')	2501003488 2501003610
		CS TRACK BLACK Extruded aluminium chromated, powder coating, factory lubricated.	10/bundle	6,10 meter (20')	2501006610
●		CS/CCS/FMS TRACK CONNECTOR Used to make a solid connection between two pieces of track.	10/box	white grey black	2518401000 2518403000 2518406000
●		CS ENDCAP UNIVERSAL LONG WITH SCREW	100/box	white silver black	2516400000 2516403000 2516406000
●		CS ENDCAP UNIVERSAL SHORT WITH SCREW	100/box	white grey black	2516401001 2516403001 2516406001
●		CS / CCS AS CARRIER "Clickable", offset, constructed of UV-resistant plastic. 10 Carriers on a break-away strip. Can be clicked in after	250/box	white silver black	2510101000 2510103000 2510106000
●		CS STOPCARRIER Clickable.	100/box	white grey	2510201000 2510203000
●		CS / CCS CARRIER AS WITH HOOK Clickable.	100/box	white grey	2510501000 2510503000
●		CS ECONOMY SLIDE Can turn in the track.	500/box 500/box	white black	2510601000 2510606000
●		CS BALL BEARING CARRIER 20MM CS BALL BEARING CARRIER 20MM CS BALL BEARING CARRIER 16MM SMALL CS BALL BEARING CARRIER 16MM SMALL CS BALL BEARING CARRIER 25MM LARGE	100/box	white black white black	2512000000 2512006000 2512000016 2512006016 2512100000
●		CS UNDERLAP CARRIER R/L	25/box	white	2514600000
●		CS OVERLAP CARRIER R/L	25/box	white	2514700000

CS	ARTICLE	PACKING UNIT	ART.NR
	 <p>CS MASTER CARRIER BASE R/L WHITE</p>	25/box	white 4814500000
	 <p>PROLONGED OVERLAP ARM 150MM R/L FOR CLICK-ON STIFFNER</p>	15/box	9500001010
	 <p>STIFFNER "CLICK-ON"</p>	15/box	5116001001
	 <p>Z-ARM UNIVERSAL 175MM R/L</p>	15/box	white 9500001030
	 <p>FMS EASYFLEX CURVED ARM R/L WHITE</p>	15/box	Pc. 5135901020
	 <p>MTS SUSPENSION CEILING BRACKET INCL TUBE Ceiling Bracket for CS. To be used in combination with the Suspension Ceiling Bracket.</p>	1/each	white 1 m (3,3') black 1,5 m (4,9') 4518201000 4518201500
	 <p>SUSPENSION BRACKET CLIP FOR KS For CS, to be used in combination with the MTS Suspension Ceiling Bracket.</p>	50/box	white black 1016901000 1016906000
	 <p>SMART KLICK CEILING BRACKET INCL COVER CAP "Klicks" onto track, powder coated.</p>	100/box	white grey black 1018201001 1018203001 1018206001
	 <p>SUSPENDED CEILING BRACKET, METAL For installation on to a suspended ceiling. The track can be fixed in any angle.</p>	25/box	4519001000
	 <p>SMART KLICK CEILING BRACKET DOUBLE LONG Distance between two tracks: 90 mm (3,5")</p>	30/box	white 1018601000
	 <p>SMART KLICK CEILING BRACKET DOUBLE SHORT</p>		1018611000
	 <p>KS ADJUSTABLE WALL BRACKET, SINGLE</p>	100/box	white grey 1020801115 1020803115
	 <p>KS ADJUSTABLE WALL BRACKET, DOUBLE</p>	50/box	white grey 1020801195 1020803195

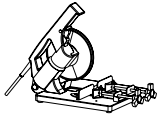
CS	ARTICLE	PACKING UNIT	ART.NR
	SMART KLICK ALUMINIUM WALL BRACKET 7,5 cm	20/box	white grey 1020301075 1020303075
	SMART KLICK ALUMINIUM WALL BRACKET 10 cm	20/box	black white grey black 1020306075 1020301100 1020303100 1020306100
	SMART KLICK ALUMINIUM WALL BRACKET 15 cm	15/box	white grey 1020301150 1020303150
	SMART KLICK ALUMINIUM WALL BRACKET 20 cm	15/box	black white grey black 1020306150 1020301200 1020303200 1020306200
	SMART KLICK ALUMINIUM WALL BRACKET 25 cm	10/box	white grey black 1020301250 1020303250 1020305250
	COVER CAP FOR SMART KLICK ALUMINIUM WALL BRACKET	50/box	white grey black 1021301000 1021303000 1021306000
	FLICKSTICK FIBERGLASS	50/box	92 cm 122 cm 152 cm 1065101092 1065101122 1065101152
	FLICKSTICK TRANSPARENT	50/box	92 cm 122 cm 152 cm 1065102092 1065102122 1065102152
	FLICKSTICK WHITE ALUMINIUM	50/box	92 cm 122 cm 152 cm 1065111092 1065111122 1065111152
	FLICKSTICK SILVER ALUMINIUM	50/box	202 cm 92 cm 122 cm 1065111202 1065113092 1065113122
	FLICKSTICK BLACK ALUMINIUM	50/box	152 cm 92 cm 122 cm 1065113152 1065116092 1065116122
	FLICKSTICK ANTIQUE ALUMINIUM	50/box	152 cm 92 cm 122 cm 1065116152 1065119092 1065119122 1065119152
	VELCRO HOTEL PROFILE Inside frame fix, to reduce light leakage in combination with Looptape	120 mtr/bundle	3581601600
	LOOPTAPE	25 mtr/roll	3816202020
	CONTRACT BENDING TOOL BASIC (without bending wheel)	1/each	2560000000
	CS/CCS/FMS BENDING WHEEL	1/each	2561000000
	CS/FMS BENDING STRIPS For CS track, length: 90 cm (35,4")	1/set	8500000001
	CS/FMS BENDING STRIP FOR ELECTRIC POWERED BENDER Length 7 meter (23')	1/piece	5160100010
	BENDING STAND Stand for contract bending tool	1/each	2560800000
	ELECTRIC POWERED BENDER Available in 230V or 115V To create continuous curves and arches minimum radius 50 cm (20")	1/each	1060500000

CS	ARTICLE	PACKING UNIT	ART.NR
●	 <p>CS/CCS BENDING WHEELS For Electric Powered Bender. Complete set of 3 wheels.</p>	1/set	2560700000
●	<p>sample image</p>  <p>ELECTRIC POWERED RAILCUTTER 230 Volt EU</p> <p>BLADE FOREST CUTTER NEW MODEL</p>	1/each	1061100000
●	 <p>FOREST LUBRICANT To lubricate components during assembly.</p>	1/each	5109010000