



DOMOTICS
READY



APP
CONTROL



WIRELESS
REMOTE



CORDED
CONTROL

FOREST ROMAN BLIND Series

Elegantly shaped aluminium profile with integrated Velcro Tape

FOREST BS®
FOREST BS® MAX
FOREST BCS®

THE WORLD
BEHIND
YOUR
CURTAINS



FOREST BLIND SYSTEM - BS®



For a more streamlined look or when space is at a premium, roman blinds that stack neatly at the top of the window when retracted are the perfect solution. With the Blind System - BS® of Forest a sleek natural look is provided for your interior. Various control options guarantee an easy and consistent operation of the roman blinds.

The Blind System - BS® is the most widely used and recognized roman blind in the industry. It comes with integrated velcro tape so that the fabric can be easily attached & removed. The system is always correctly aligned due to the twistlock on the cord roll support. For the ultimate convenience a motorized control option is possible. Operate the Blind System at the press of a button or by your smartphone.

PRODUCT INFORMATION

- Hand drawn and motorised control options.
- For all types of light and medium weight draperies.
- Elegant shaped aluminium profile, with integrated Velcro hook tape.
- Available height: 3,50 meter (11,5").
- Available width: 5.80 meter (19").
- Simple face-fix and top fix installation.
- Conic shaped drums; thus smooth and straight operation of the system is guaranteed.
- Self-braking endless chain control units.
 - 1:1 (fabric weight up to 3,5 kg)
 - 1:4 (fabric weight up to 7,5 kg)
- Total maximum fabric weight up to 7,5 kg.
- Motorised: Total maximum fabric weight up to 4 kg.
- Colour available: white.
- Special Child Safety solution possible.
- Track finish: chromated powder coated.
- Warranty Manual System: 10 year.
- Warranty Motorised System: 5 year.

FOR USE IN

Hotels, offices, residences, boats, campers, planes or anywhere an efficient Velcro track system for roman shades is required.

CONTROL OPTIONS





PROFILE

- Weight 409 gr/mtr
- Aluminium extrusion 6063 T5
- Size 33.3 x 36.7 mm (1.3" x 1.4")
- Colour available: white

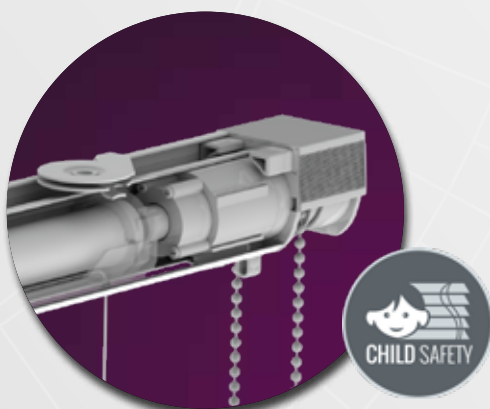
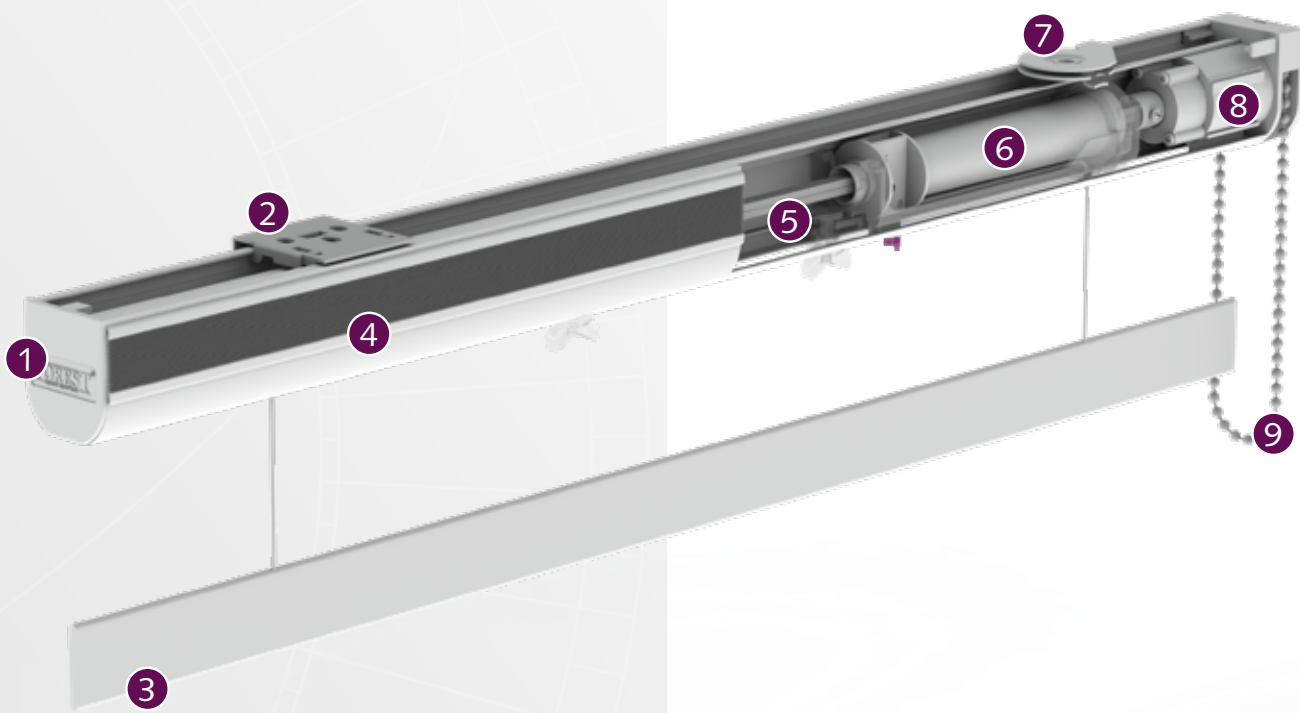
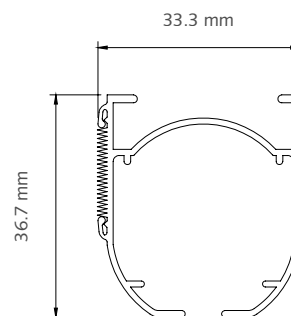

- ① BS Endcap
- ② BS Smart Klick® Ceiling / Wall Bracket
- ③ Counterweight bar 6 x 20 mm.
- ④ BS Track incl. Velcro Hook Tape
- ⑤ BS Rod 5x5mm
- ⑥ BS Quicklock Cord Roll
- ⑦ BS Ceiling bracket, swivel
- ⑧ BS Control Unit 1:4
- ⑨ Chain

FOREST BLIND SYSTEM MAX - BS MAX®



To complement the manual range of the roman blind systems for heavier duty drapery, Forest introduces the Blind System Max®.

The Forest BS Max® is developed for taller windows and heavier fabrics. This roman blind system can go up to a height of 4.80 meter with a total weight of 13 kg. It comes with integrated velcro tape so that the fabric can be easily attached & removed.

PRODUCT INFORMATION

- Hand drawn roman blind system.
- For all types of medium and heavy weight draperies.
- Elegant shaped aluminium profile, with integrated Velcro hook tape.
- Available width: 5.80 meter (19").
- Available height: 4.80 meter (15,75").
- Simple face-fix and top fix installation.
- Cords are easy to remove; very useful when washing or dry cleaning the fabric.
- Self-braking endless chain control units.
- Maximum fabric weight per cord roll: 4 kg and total system 13 kg.
- Colour available: white.
- Track finish: chromated powder coated.
- 10 year warranty

FOR USE IN

Hotels, offices, residences, boats, campers, planes or anywhere an efficient Velcro track system for roman shades is required.

CONTROL OPTION





PROFILE

- Weight 694 gr/mtr
- Aluminium extrusion 6063 T5
- Size 53.2 x 53.5 mm (2.0" x 2.1")
- Colour available: white

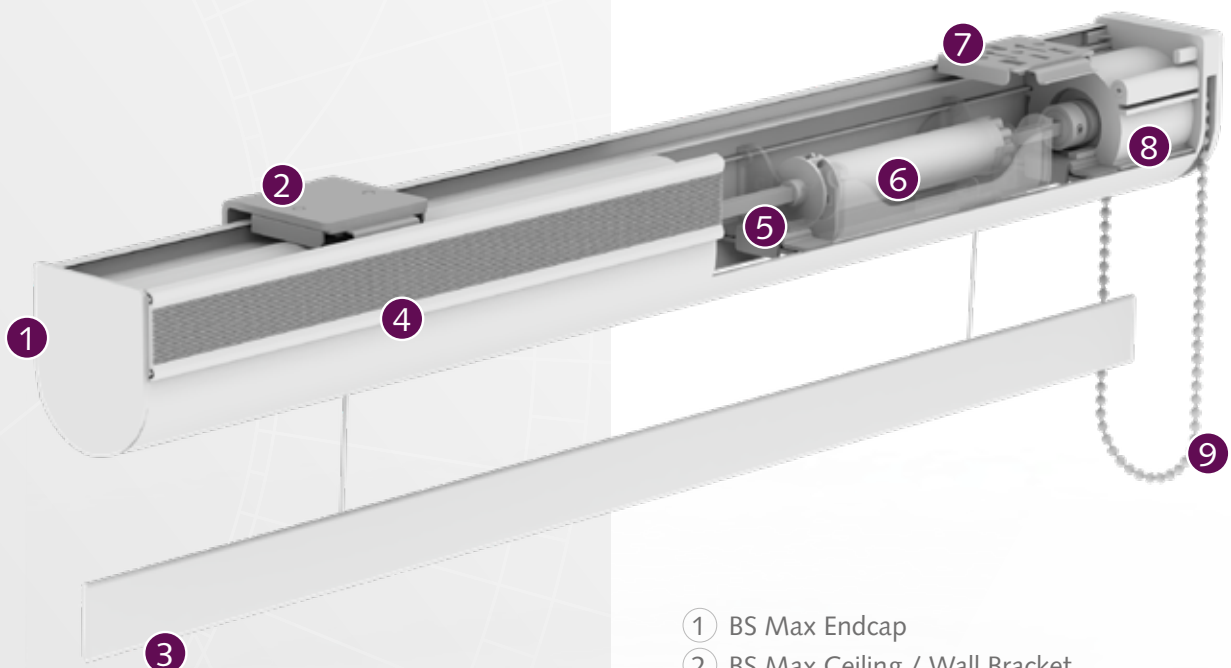
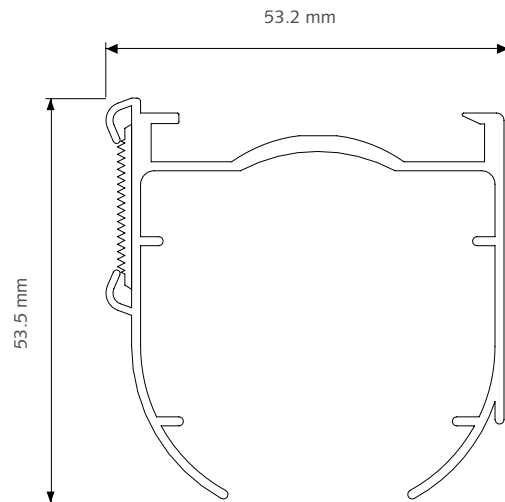

- 1 BS Max Endcap
- 2 BS Max Ceiling / Wall Bracket
- 3 Counterweight bar 6 x 20 mm.
- 4 BS Max Track incl. Velcro Hook Tape
- 5 BS Rod 5x5mm
- 6 BS Max Cord Drum
- 7 BS MaxHidden Ceiling Bracket
- 8 BS Max Control Unit 1:4
- 9 Chain

FOREST BLIND CONTRACT SYSTEM - BCS®



Another solution of Forest is the motorized roman blind 'BCS®-system', developed especially for taller window frames and heavier fabrics. The tubular motor in the system is 220 Volt and available in variable voltages as required. A powerful 121 Watt motor is standard, capable of lifting blinds of up to 13 kg; other motor types - capable of up to 26 kg - are available upon request. The cord coils can hold 5.5 meter of cord.

The Forest roman blind BCS® system is suitable for all current control systems and incorporates a unique, patented cord braking system. If, for any reason, the roll down action of a blind is obstructed, the motor automatically trips out to prevent the blind leaning and the cord breaking.

FOR USE IN

Domestic and/or project market, or at any location where a high quality and smooth operated motorized blind system is requested.

PRODUCT INFORMATION

- Motorised roman blind system.
- For all types of medium and heavy weight draperies.
- Elegantly shaped aluminium profile, with Velcro Hook Tape
- Available width: 5.80 meter (19").
- Available height: 5.50 meter (18").
- Simple and quick installation with Smart Klick® bracket.
- Cords are easy to remove; very useful when you want to wash or dry cleaning the fabric.
- Can be controlled by wall switch, remote control (high frequency).
- Easy to connect to building automation systems.
- Easy to connect with third party Apps (Apple Homekit or Google Assistant) by the Forest Wireless Connector.
- Cord Drums can be placed on every position in the profile.
- Maximum fabric weight per cord roll: 4 kg.
- Tubular motor also available with internal Multi receiver and electronic limit setting.
- Track finish: aluminium, chromated, powder coated.
- Warranty Manual System: 10 year.
- Warranty Motorised System: 5 year.

CONTROL OPTIONS





PROFILE

- Weight 1092 gr/mtr
- Aluminium extrusion 6063 TS
- Size 63 x 74 mm (2.4" x 2.9")
- Colour available: white

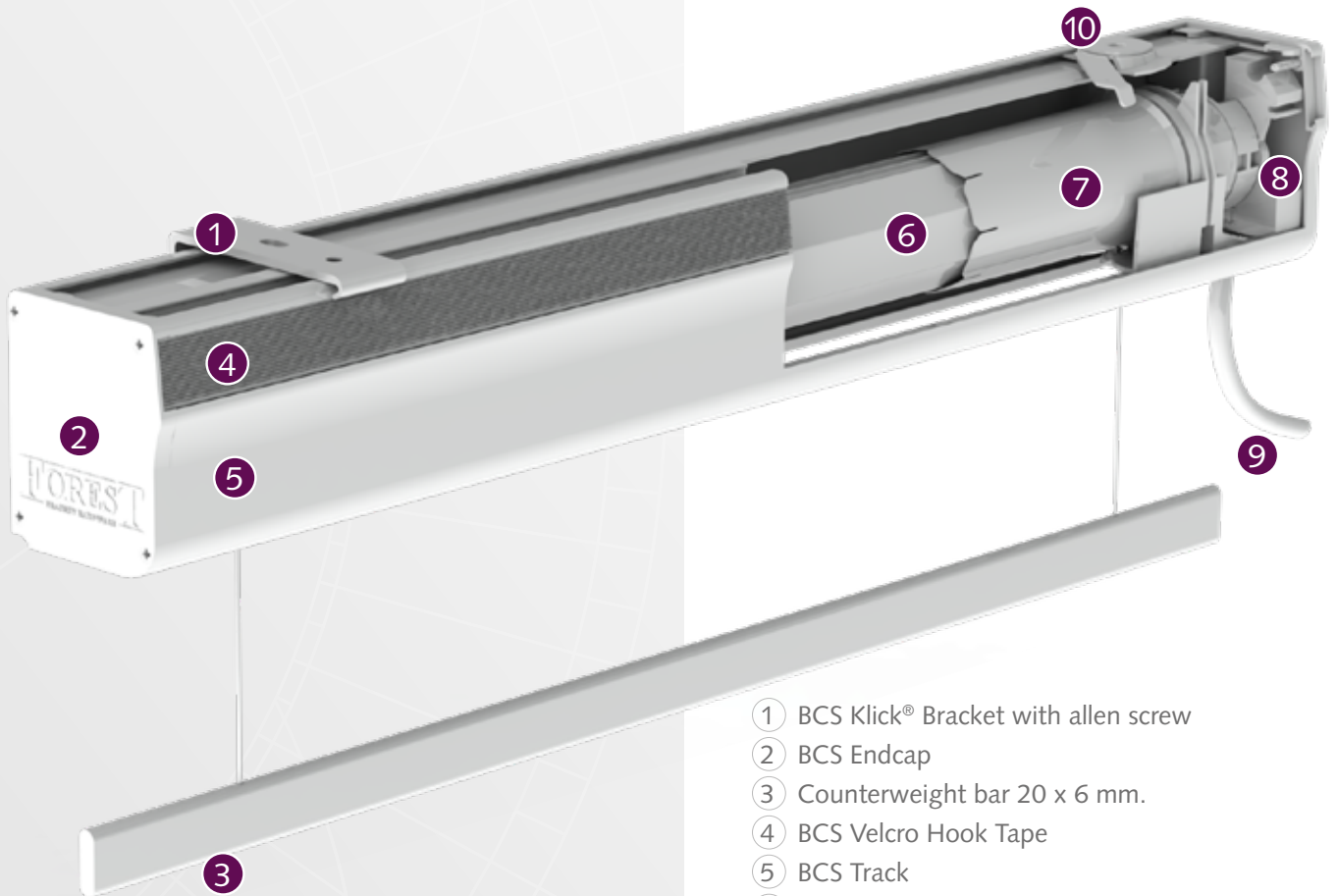
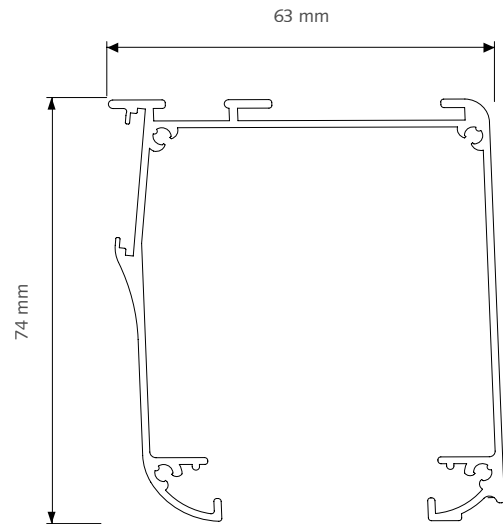

- ① BCS Klick® Bracket with allen screw
- ② BCS Endcap
- ③ Counterweight bar 20 x 6 mm.
- ④ BCS Velcro Hook Tape
- ⑤ BCS Track
- ⑥ BCS Tube 8-angular
- ⑦ BCS Cord Roll House Complete
- ⑧ BCS Centre Support
- ⑨ Forest Tubular Motor
- ⑩ Ceiling Swivel Bracket

FOREST BLIND CONTRACT SYSTEM - BCS®

SPECIFICATIONS

Type	Strength	Speed	Weightload	Noise level	Internal Receiver	Control options
6/28/S	6 Nm	28 rpm	13 kg	< 44 dB(A)	No	Home Automation / Forest Multi Receiver Wall Switch
6/20/SQ	6 Nm	20 rpm	13 kg	< 40 dB(A)	No	Home Automation / Forest Multi Receiver Wall Switch
13/14/S	13 Nm	14 rpm	26 kg	< 44 dB(A)	No	Home Automation / Forest Multi Receiver Wall Switch
6/28/E	6 Nm	28 rpm	13 kg	< 44 dB(A)	Yes	Forest Remote / Wireless Wall Switch / Forest Wireless Connector
6/20/EQ	6 Nm	20 rpm	13 kg	< 40 dB(A)	Yes	Forest Remote / Wireless Wall Switch / Forest Wireless Connector
13/14/E	13 Nm	14 rpm	26 kg	< 44 dB(A)	Yes	Forest Remote / Wireless Wall Switch / Forest Wireless Connector

MOUNTING

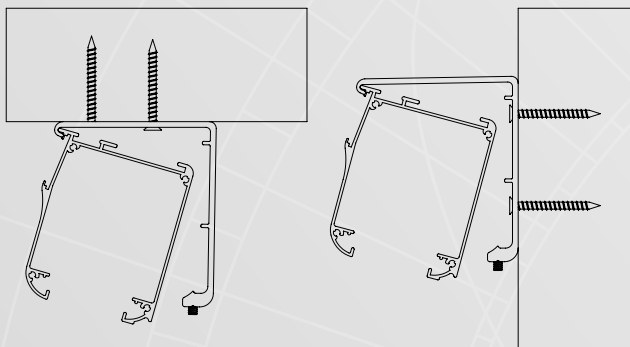

Wall and ceiling fixing is possible

ADJUSTING MOTOR

The limit settings for the tubular motors can be done as follows:

- S motors, mechanically by means of an allen key.
- E motors, electronically by means of a Forest Remote or RF Wall Switch.



SMART FUNCTIONS

Suited for all Forest motorised Blind Systems, the Forest Wireless Connector is an easy way to make roman blinds 'smart'. It simply opens and closes the blinds in combination with an analogue timer.

By using a smart plug wireless control through services such as Apple HomeKit or Google Assistant or Forest Connect app now becomes available. This RF Device can also be easily incorporated into most popular building management systems, including dry contact systems.



Scan the QR code with your smartphone and watch the video how the Wireless Connector works.

WORKS WITH



* Only works with actor.

Forest BCS® is compatible with many other Building Automation systems, thanks to its modular construction. A competitive advantage over other motorised drapery systems in the world!

CONTROL OPTIONS

Our broad range of controls make finding a fit for your home even easier; controlling the blinds by hand, remote or even by building automation system. With the remote you can control the blinds in any position you like. Controlling the motorized blind system by your smartphone or tablet, you can create and schedule customized room scenes that allow your blinds to operate on their own throughout the day.



FOREST WIRELESS CONNECTOR

The Forest Wireless Connector is an easy way to make the motorised Blind Systems 'smart'. This wireless remote solution works in combination with an analogue timer or a smart plug with which services as Apple Home Kit or Google Assistant become available. With the Forest Smart Plug it is possible to control by the Forest Connect app. The Wireless Connector is also easily incorporated into most popular building management systems, including dry contact controls.



FOREST DIAMOND SENSE REMOTE

15 Channel remote control, possibility to control up to 15 systems individually and in group by integrated timer function or manual. Auto-On mode, when holding hand above it, the integrated LED light will automatically come on. Radio control, range up to 30 meters. Including magnetic wall support.











BUILDING AUTOMATION

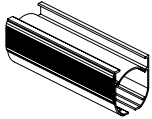

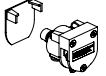
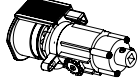

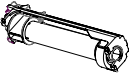
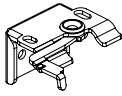
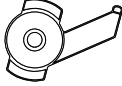
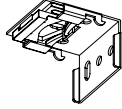
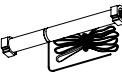
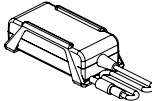
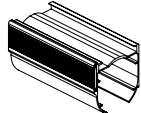

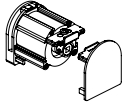
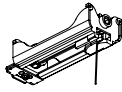
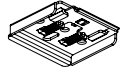

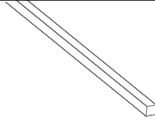
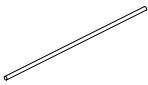
The BCS® system can be connected to any Building Automation system, by relay control.

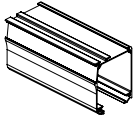

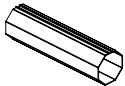
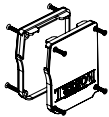
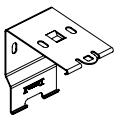
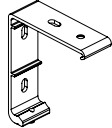
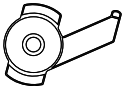
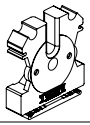
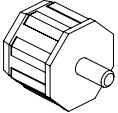
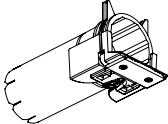







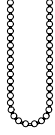
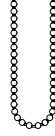
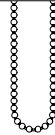

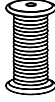

HOTEL CONTROL

The BCS® system can be connected to any Hotel Automation system, by relay control.

BS	BS-MAX	BCS	ARTICLE	PACKING UNIT	ART.NR	
●			 <p>BS TRACK Extruded aluminium chromated white powder coated, with Velcro hook tape on front of the track. Available length: 5,8 mtr. (19 Ft.)</p> 	58 mtr./bundle white	3601001580	
●			 <p>BS CONTROL UNIT 1:4 Incl. endcap Heavy duty, Self-braking. Operation by chain.</p>	100/box white	3611001014-L	
			 <p>BS CONTROL UNIT 1:1 Incl. endcap</p>		3611001011-L	
●			 <p>CHILD SAFETY CONTROL UNIT 1.4 incl. endcap</p> 	100/box white	3611001000	
●			 <p>QUICKLOCK CORD ROLL incl. 3.5 mtr. cord (different color types cord available upon request, see for colour options BS/BCS Cord)</p>	100/box white/transparent	3642401350	
			without cord		3642400000	
●			 <p>BS WALL BRACKET, SWIVEL Metal</p>	100/box white	3663001000	
●			 <p>BS CEILING BRACKET, SWIVEL</p>	100/box white	3661000000	
●			 <p>BS SMART CLICK WALL / CEILING BRACKET Metal</p>	100/box white	3662000000	
●			 <p>BS MOTOR 24V</p>	1/box	3648000000	
●			 <p>FOREST ADAPTOR FOR BS MOTOR Forest adaptor with support bracket for BS motor (without cable)</p>	1/box white	5232003002	
			Cable with plug available in versions	1/box	EU UK AUS USA	5201001101 5201001131 5201001141 5201001121
●			 <p>BS MAX TRACK Extruded aluminium chromated white powder coated, with Velcro hook tape on front of the track Available length: 5,8 mtr (19 Ft.)</p> 	46,4 mtr./bundle white	3710001580	
●			 <p>BS MAX CONTROL UNIT 1:4 with endcap</p>	50/box white	3711001014	
●			 <p>BS MAX CORD DRUM incl. 4,8 mtr. cord</p>	50/box white/transparent	3711000480	
●			 <p>BS MAX HIDDEN CEILING BRACKET</p>	50/box white	3711000000	
●			 <p>BS MAX L-CEILING /WALL BRACKET</p>	100/box white	3711000001	
●	●		 <p>BS ROD 5X5 MM ALUMINIUM Aluminium 5 x5 mm (0,20" x 0,20") Available length: 5,8 mtr (19 Ft.)</p>	10/bundle	3630000580	
●	●	●	 <p>FIBEROD 6 meter length 4mm diameter</p>	600 mtr. / bundle	3535301600	

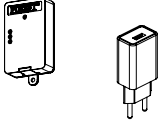
BS	BS-MAX	BCS	ARTICLE	PACKING UNIT		ART.NR
		●	 BCS TRACK Extruded aluminium chromated white powder coated Available Length 5,80 mtr (19 Ft.)	500 mtr./roll	white	3416101000
		●	 BCS VELCRO HOOK TAPE 25 mm height. 1,20 meter length	1/box	white	3416500004
		●	 BCS TUBE 8-ANGULAR Length 5,80 mtr (19 Ft.)	1pc	white	3416102000
		●	 BCS ENDCAPS LEFT/RIGHT	25 sets/ box	white	3416201000
		●	 BCS EASY MOUNT WALL / CEILING BRACKET For wall and ceiling fixing.	25/box	white	3416301010
		●	 BCS MOUNTING BRACKET WITH ALLEN SCREW For wall and ceiling fixing.	25/box	white	3416301020-B
		●	 CEILING SWIVEL BRACKET For ceiling fixing.	100/box	white	3818200450
		●	 BCS CENTRE SUPPORT Dimension: 51 x 56 mm.	25/box		3416500000
		●	 BCS TUBE SUPPORT 8-ANGULAR To be placed on the open end of the 8 angular tube.	25/box		3416500003
		●	 BCS CORD DRUM COMPLETE Incl. 5.5 mtr white cord.	25/box		3416500002
		●	 BCS OBSTRUCTION SENSOR For use in combination with the Forest Tubular Motor with built-in receiver (E & EQ) Set 230V.	1/box	white	3416800000
		●	 FOREST TUBULAR MOTOR Ø 35MM 6/28/S 13/14/S	1/box	230v/50hz 6nm/28rpm 230v/50hz 13nm/14rpm	3416600012 3416600016
		●	 FOREST SILENT TUBULAR MOTOR Ø 35MM 6/20/SQ	1/box	230v/50hz 6nm/20rpm/SQ	3416600017
		●	 FOREST TUBULAR MOTOR Ø 35MM WITH INTERNAL RECEIVER 6/28/E 13/14/E	1/box	230v/50hz 6nm/28rpm 230v/50hz 13nm/14rpm	3416600112 3416600116
		●	 FOREST SILENT TUBULAR MOTOR Ø 35MM WITH INTERNAL RECEIVER 6/20/EQ	1/box	230v/50hz 6nm/20 rpm/EQ	3416600117
●	●	●	 COUNTER WEIGHT BAR 6 MTR	60 mtr./bundle 60 mtr./bundle 90 mtr./bundle 30 mtr./bundle	6 x 20 mm white 3 x 25 mm white 3 x 40 mm white 5 x 25 mm white	3501701600 3801400600 3801401600 3801402600

BS	BS-MAX	BCS	ARTICLE	PACKING UNIT		ART.NR
●	●		 ROMAN BLIND CHAIN 6 MM PITCH METAL STAINLESS STEEL	roll 1/bag	rol 150 mtr 1.50 mtr (drop=0.75 mtr) 2.00 mtr (drop=1.00 mtr) 2.50 mtr (drop=1.25 mtr) 3.00 mtr (drop=1.50 mtr) 3.50 mtr (drop=1.75 mtr) 4.00 mtr (drop=2.00 mtr) 4.50 mtr (drop=2.25 mtr)	3670008100 3670008150 3670008200 3670008250 3670008300 3670008350 3670008400 3670008450
●	●		 ROMAND BLIND CHAIN 6 MM PITCH METAL	roll 1/bag	rol 150 mtr 1.50 mtr (drop=0.75 mtr) 2.00 mtr (drop=1.00 mtr) 2.50 mtr (drop=1.25 mtr) 3.00 mtr (drop=1.50 mtr) 3.50 mtr (drop=1.75 mtr) 4.00 mtr (drop=2.00 mtr) 4.50 mtr (drop=2.25 mtr) 5.00 mtr (drop=2.50 mtr) 6.00 mtr (drop=3.00 mtr)	3670003100 3670007150 3670007200 3670007250 3670007300 3670007350 3670007400 3670007450 3670007500 3670007600
●	●		 BS ENDLESS CHAIN 6 MM PITCH WHITE Also available in color grey For grey use (4) instead of (2)	1/bag	1.00 mtr (drop=0,50 mtr) 1.50 mtr (drop=0.75 mtr) 2.00 mtr (drop=1.00 mtr) 2.50 mtr (drop=1.25 mtr) 3.00 mtr (drop=1.50 mtr) 3.50 mtr (drop=1.75 mtr) 4.00 mtr (drop=2.00 mtr) 4.50 mtr (drop=2.25 mtr) 5.00 mtr (drop=2.50 mtr) 6.00 mtr (drop=3.00 mtr)	3670002100 3670002150 367000(2)200 367000(2)250 367000(2)300 367000(2)350 367000(2)400 367000(2)450 367000(2)500 3670002600
●	●		 CHAIN JOINTING PLIER For joining two ends of the metal chain together	1/box		3675900001
●	●		 CORD/CHAIN WALL MOUNT SAFETY BOX SINGLE	25/box		3645702000
●	●		 CORD/CHAIN WEIGHT DESIGN	10/box	white grey black	3030701000 3030703000 3030706000
●	●	●	 LOOP TAPE 20MM To be fixed onto the curtain fabric	25 mtr./roll		3816202020
●	●	●	 ROMAN BLIND CORD For use in combination with Cord Roll Support / Cord Drum. Thickness: 1.3 mm.	500 mtr/roll	white (selection of 17 colours available upon request: corn, grey, off-white, brown, black, steel grey, old pink, mocca, creme, beige, blue, terra, moss, salmon, aubergine, green, pink)	3645001000
●	●	●	 SNAP CORD FIXER For easy adjustment of the bottom side of the blind	100/box	transparent	3647001001
●	●	●	 SNAP CORD FIXER CHILD SAFETY	100/box	transparent	3611001001
●	●	●	 FOREST WIRELESS WALL SWITCH 2 CHANNEL LED	1/box	white black	5201001480 5201006480
●	●	●	 FOREST MULTI RECEIVER WALL SWITCH For motor without internal receiver	1/box	white	5104011500
●	●	●	 FOREST DIAMOND SENSE REMOTE 15 CHANNEL INCL TIMER	1/box	white black	5201091470 5201086470
●	●	●	 FOREST WIRELESS CONNECTOR Incl.15cm USB cable excl. USB power plug One way transmitter to integrate system in Domotic System. To control by third apps like Google Home, Amazon Alexa or Apple Homekit use a (third-party) smart plug.	1/box	white USB power plug EU USB power plug UK USB power plug AU USB power plug US	5201002270 5201002271-EU 5201002271-UK 5201002272-AU 5201002274-US
●	●	●	 FOREST SMART PLUG WHITE The Forest Smart Plug allows App control via the Forest Connect App (the Forest Wireless Con- nector is required)	1/box	EU UK AU US	5201001952-EU 5201001953-UK 5201001954-AU 5201001955-US